



SolarStrap™

Patents Pending

TPO/PVC Attachment Installation Guide



SolarStrap™ Installation Manual
Copyright© 2017 by PermaCity. All rights reserved.

www.solarstrap.com

The SolarStrap™ is made in the U.S.A. with quality assurance. The unique features of this product and design are patent pending and copying of PermaCity intellectual property without its written consent is prohibited and subject to strict enforcement.

The information contained herein is subject to change without notice.

Invented, Designed, and Manufactured by:

PermaCity Solar
525 S. Hewitt St.
Los Angeles, CA 90013
(323) 692-9264
www.permacity.com



Wind Tunnel Tested per ASCE Standard 7, 91.1609 LAMC
Approval No. 00303



UL1703 20150519 §48.1.b)1): The system achieves a Class A fire rating when installed in the manner specified in these instructions.

UL2703 First Edition 20150128 §26.1: The system has achieved a Class A fire rating when installed with Type 1 and Type 2 modules.

UL 2703 Certificate No. US 82160016



ul.com

File No. E356152

UL467 Report: QIMS2.E356152

UL467 Intertek Report: 101005952LAX-001

UL1703: Class A Pending or currently exempt as a roof mount only system (subject to module fire class rating)

UL2703 Certificate of Compliance: 20140820 – E356152



www.akstamping.com

 **CAUTION**

Installer must read this manual before attempting installation. Failure to correctly establish the requirements of the proposed installation site is dangerous and can void the framing or roofing warranty.

Contents

Before You Start	4
Handling & Installing	4
Roof Loading, Wind Uplift Resistance, and Seismic Attachments	4
Features	4
System Overview	5
Exploded Diagram	5
Preparing to Build	6
Components	6
Required Tools and Safety Equipment	7
Planning and Layout	8
Setting up the Roof	8
Installation	9
Lay Down Straps	9
Add Brackets	10
Place Modules	11
Mid Clamp with Integrated Ground Installation	12
End Clamp with Integrated Ground Installation	12
Wire Management and Grounding	13
Grounding the Array Example	14
Seismic Engineering	15
Application of Seismic Building Codes	16
Roof Connection	17
Attachment Details	17
Notes	18
Parts List	18
Certification and Approved Modules	19
TÜV UL2703 - Conformance	19
TÜV UL2703 - Approved Modules	19
Warranty	20
SolarStrap™ Limited Warranty Statement	20

BEFORE YOU START

Handling & Installing

It is critically important to observe standard safety practices when installing SolarStrap™:

- Follow all OSHA safety guidelines for construction safety.
- Stop work during stormy weather. Solar modules, SolarStraps, and other components can be blown off the roof in high winds.
- Always secure solar modules, SolarStraps, and other components from unexpected high winds while under construction. Wind blown construction materials are a safety hazard.
- Never step or sit on the glass surface of a solar module. The glass may break, resulting in shock or bodily injury.
- Do not throw or roughly handle any SolarStrap™ components.
- Do not bring SolarStrap™ into contact with sharp or heavy objects.
- Do not modify SolarStrap™ components in any way. The exchange of bolts, drilling of holes, bending and any other physical changes not intended in standard installation procedure will void the warranty.
- Products should be installed and maintained by qualified personnel. Keep unauthorized personnel away from solar modules.
- It is the installer's responsibility to verify the integrity of the structure to which SolarStrap™ is used. Roofs or structures with rotten/rusted bearers, undersized bearers, excessively spaced bearers or any other unsuitable substructure cannot be used with SolarStrap™. Installation on such structures could result in death or serious injury.

Roof Loading Resistance, and Seismic Attachments

Roof loading calculation are based on code approved stress equations and allowable margins of safety. Roof loading calculations must be conservatively performed under wind loads, snow, and dead loads. Components have had full envelope forces applied to each component from engineered data sets approved by the engineer of record. The engineer of record will review PermaCity wind data tables and choose the appropriate wind uplift values by boundary roof zones. The engineer of record will choose and compute the quantity and method of positive seismic attachments required based on roof type, roof substructure and seismic locations. This data is either provided as part of the project engineering or from a SolarStrap code compliant data set.

Features

- Aluminum 5052 - 6061
- Suitable for most buildings
- Suitable for roof slope range $0^\circ < 9.5^\circ$
- Panel array weight under (3) Lbs/sf
- High strength-to-weight ratio
- Spacing efficiency with integrated setback adjustments
- High corrosion resistant materials resulting in low lifetime maintenance and an extended product life
- Complies with SEAOC 7-05 guidance for wind load design
- Complies with SEAOC PV-2 and ASCE 7-10
- Complies with SEAOC PV-1 guidance for wind tunnel tested arrays
- Ballast only option under (5) Lbs/sf in most Western U.S. locations
- Tested to 120 MPH wind zones, calibrated to 150 MPH

SYSTEM OVERVIEW

Diagram

The SolarStrap™ is fast and easy to install with minor field measurements required. The PanStrap option is available when used in conjunction with PermaCity's wind tunnel test data in compliance with SEAOC PV-2 Guidelines.

Note: The SSSS4 or SSOP3 will need to be in every installation for that installation to retain Fire Rating. (UL2703 First Edition 20150128 §26.1)



Components

SolarStrap™ One Piece
SSOP3 



SolarStrap™ Low Bracket
(5°, 10°, 15°)
SSLB



SolarStrap™ High Bracket
(5°, 10°, 15°)
SSHB



SolarStrap™ Attachment
Plate/Heavy Duty
SSAP/SSAPHD



Conductive Mid Clamp
A3004



Conductive End Clamp
A3003



Grounding Lug
SGB-4



Grounding Lug
SGB-5



Serrated Hex Flange Nut
SSHWSFN



SolarStrap™ Inverter Mount Rack**
SSIMR



Full Threaded
Hex Bolt
SSHWHB

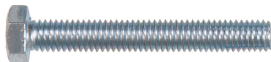

Lock Washer
SSHHLW



Required Tools and Safety Equipment

Chalk Line Reel



Drill with Impact Driver



Measuring Tape

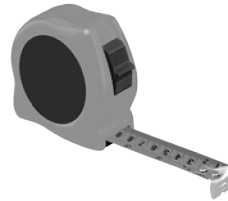

Torque Screw Driver



Footwear



Gloves



Hard Hat



Safety Glasses



Safety Harness



Safety Vest



PLANNING AND LAYOUT

Roof Layout

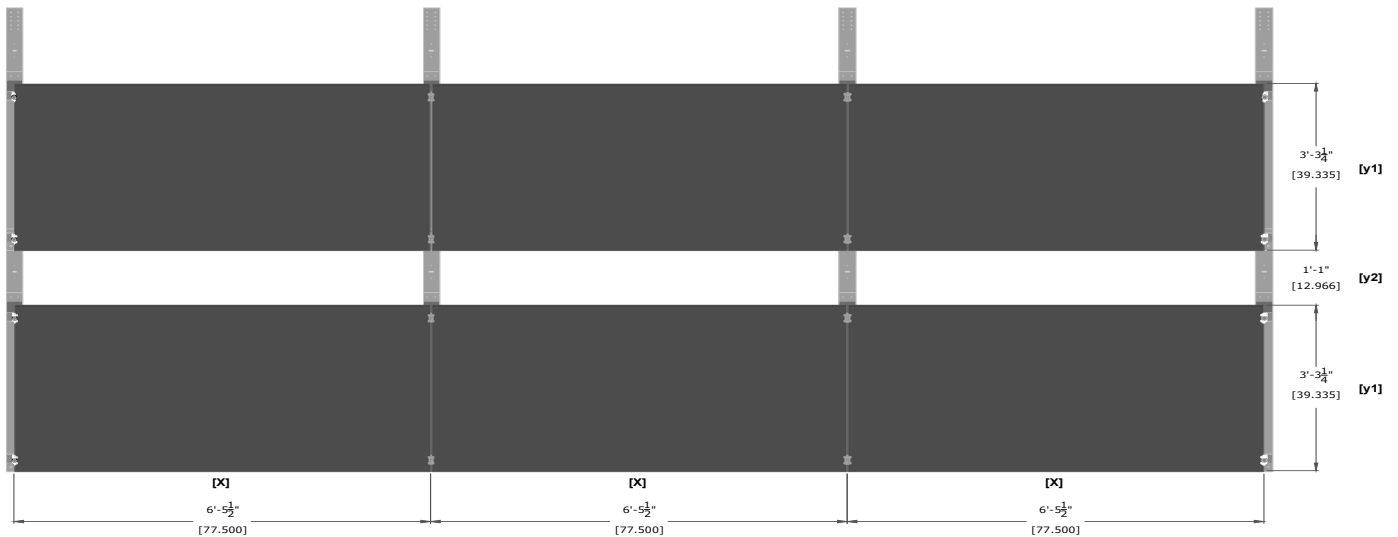

- Identify interlock set point on SolarStrap™ (y2). Verify plan set to check correct slot to inter-lock.
 - x = Length center to center or end to center, including end and mid clamps
 - x¹ = Length of the center of the module to the center of strap
 - x² = Length of the strap to the center of the strap
 - x³ = Space in-between modules 3/4" minimum
 - y¹ = Inter-lock set point on SolarStrap™
 - y² = Distance for inter row shading

INTER-ROW SPACING IS DETERMINED BASED ON THE TILT ANGLE OF THE PV SYSTEM AND INTER-LOCK SETTING OF THE SOLARSTRAP RACKING SYSTEM.

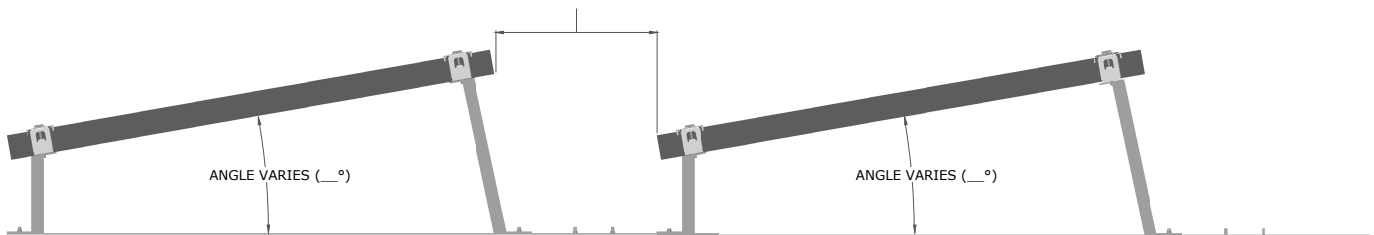

CAUTION

- AHJ may request seismic attachment for certain zones. Verify with your local department of building and safety.
- Be careful to follow final design layout.
- Installer must verify that PV Module manufacturer's attachment points for clamps are met to avoid damage, injuries and module warranty being voided.
- Installers must verify that all building requirements specific to installation site are met, including city, fire department, and other jurisdictions responsible for Residential/Commercial roof inspections.
- Installer must follow all OSHA CFR1926 rules and regulations regarding Job-site safety, fall protection and PPE. For more info visit: www.osha.gov

PLANNING AND LAYOUT

Roof Layout

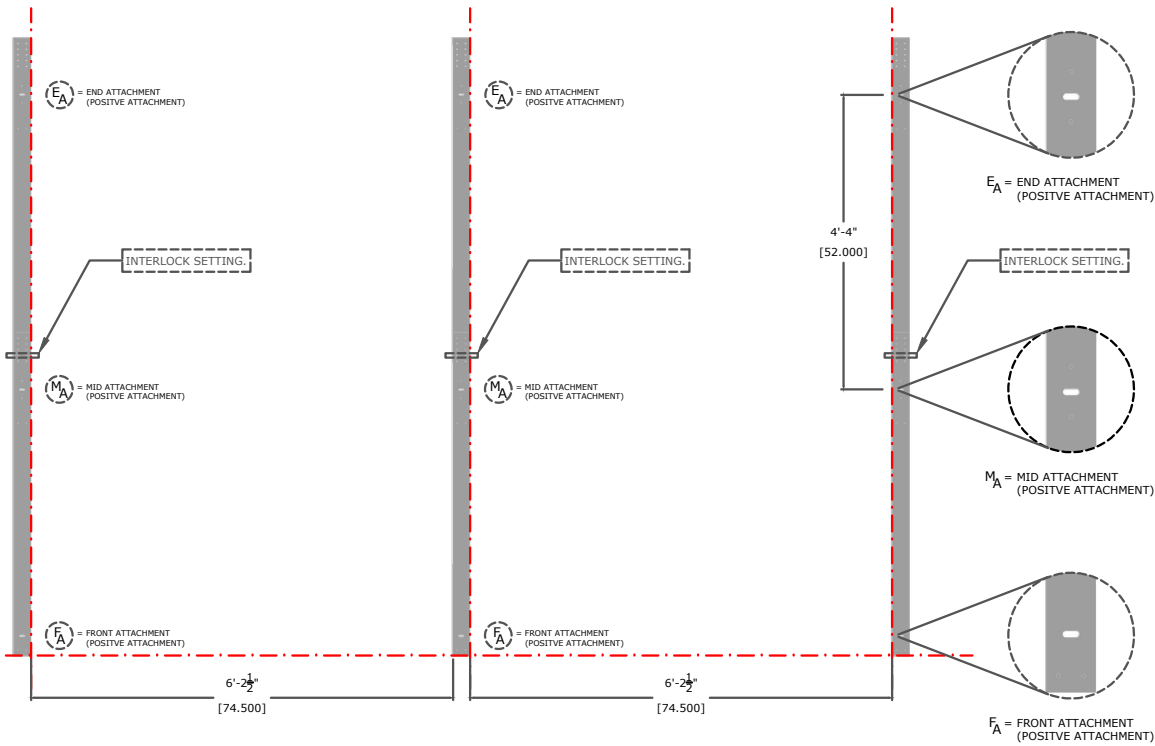

NOTE:

ONCE THE CORRECT INTERLOCK SETTING HAS BEING ESTABLISHED BY PERMACITY AND/OR APPROVED PLANS BY AHJ/BUILDING DEPARTMENT, INTERLOCK ALL SSOFP3 - SOLARSTRAP TO THE ESTABLISHED SETTING. THIS WILL MAKE THE INSTALLATION AND MOUNTING OF SOLARSTRAP COMPONENTS AND SOLAR EQUIPMENT FAST AND EASY.

POSITIVE ATTACHMENT:

USE FOR THE FOLLOWING ROOF(S): ASPHALT, PLYWOOD, OSB, CONCRETE, METAL DECK, RAFTERS. PLEASE ENSURE CORRECT FASTENER IS USE FOR SPECIFIC ROOF. CONSULT YOUR ENGINEER AND/OR USE FASTENERS ON APPROVED PLAN SET.



TPO/PVC ATTACHMENT:

USE FOR THE FOLLOWING ROOF(S): TPO, PVC, ASPHALT, PLYWOOD, OSB, CONCRETE, METAL DECK, RAFTERS. PLEASE ENSURE CORRECT FASTENER IS USE FOR SPECIFIC ROOF. CONSULT YOUR ENGINEER AND/OR USE FASTENERS ON APPROVED PLAN SET.

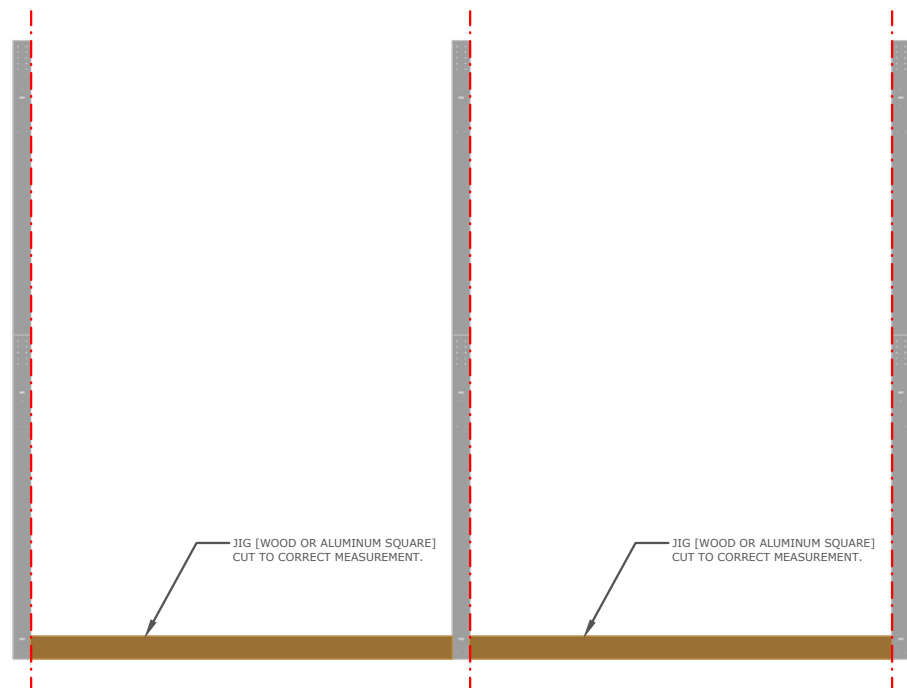
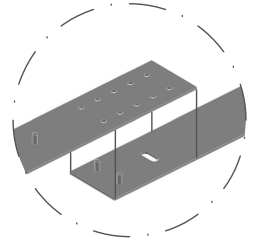

NOTE:

TO MAKE THIS INSTALLATION FAST, EASY, AND ACCURATE, YOU CAN DO THE FOLLOWING TO LOCATE AND PLACE THE SSOFP3 - SOLARSTRAP AND SSAP - ATTACHMENT PLATES. [USE A JIG (2 x 4 WOOD/STUD OR ALUMINUM BAR, CUT TO THE CORRECT SIZE. THIS CAN BE PROVIDED BY PERMACITY OR CAN BE ACQUIRED ONCE YOU MARK THE ROOF.

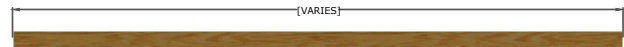

INSTALLATION

Add Brackets

After SolarStraps are laid down, simply place brackets with top flanges facing inwards. The low bracket is for the sun-facing side and the high bracket for the shade-facing side. Fasten the Serrated Hex Flange Nuts to secure brackets to a torque of 55 in.-Lbs. See Mid and End Clamp instruction on page 12.

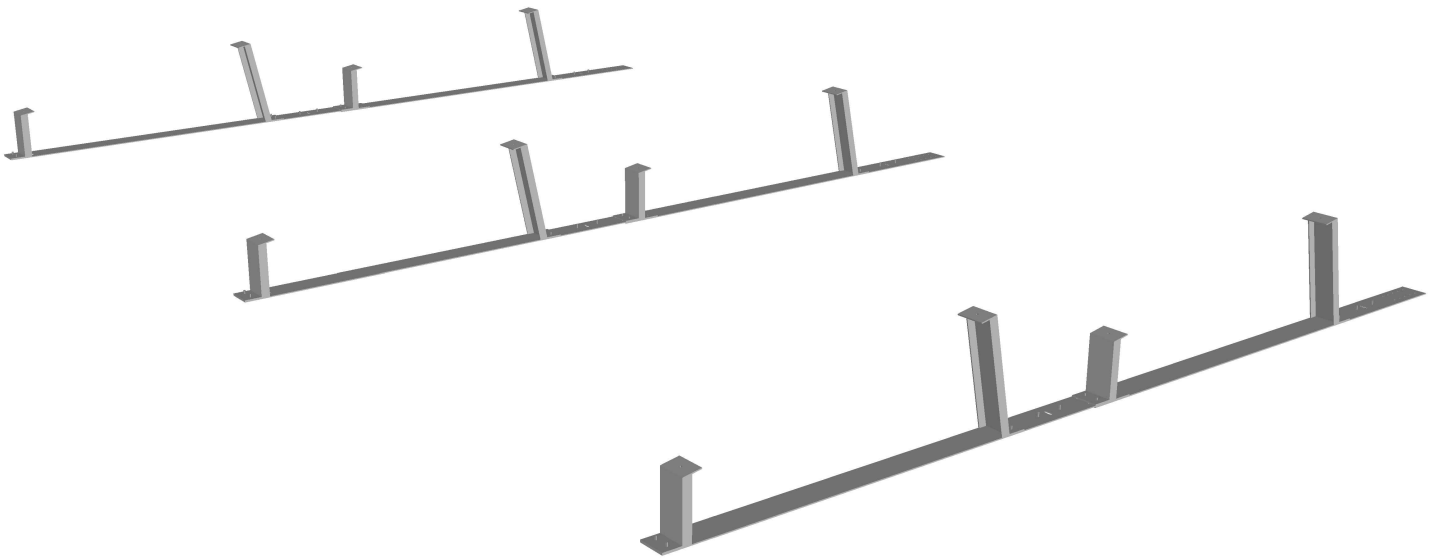

NOTE:

PLACE SSLB - LOW BRACKET AND SSHB - HIGH BRACKET OVER INTEGRATED PEM STUDS STICKING UP THE SSOP3 - SOLARSTRAP TO SECURE THE BRACKETS USE SSHWSFN - 1/4" SERRATED FLANGE NUT AND FASTENED TO 55 IN-LBS.

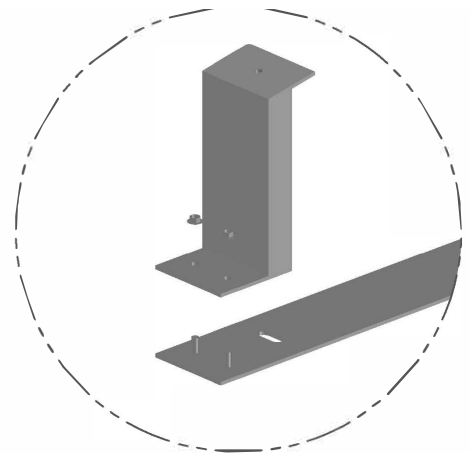

Place Modules

After brackets are secured, simply place modules on brackets. Install mid and end clamps and torque to 55 in.-Lbs. See Mid and End Clamp instruction on page 12.

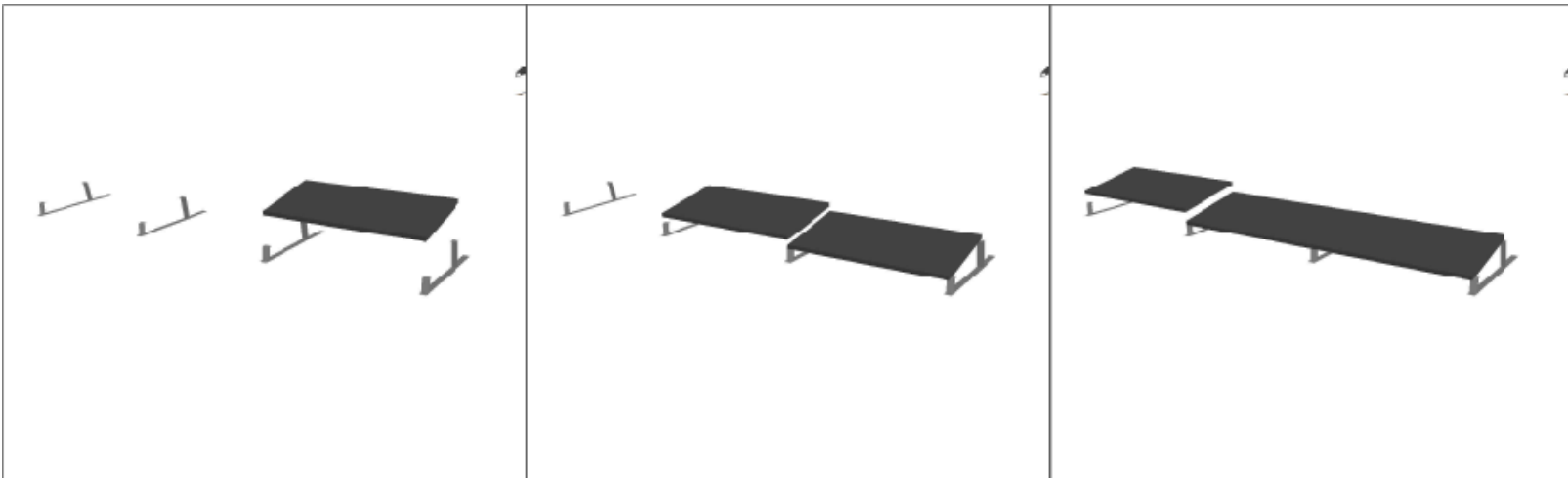

SolarStraps must be secured by using "Conductive Mid Clap and End Clamp" for framed modules and "Frameless End Clamps" for Framless Modules.



CAUTION

Never leave unsecured modules on the roof unattended.

INSTALLATION

Mid Clamp with Integrated Ground Installation

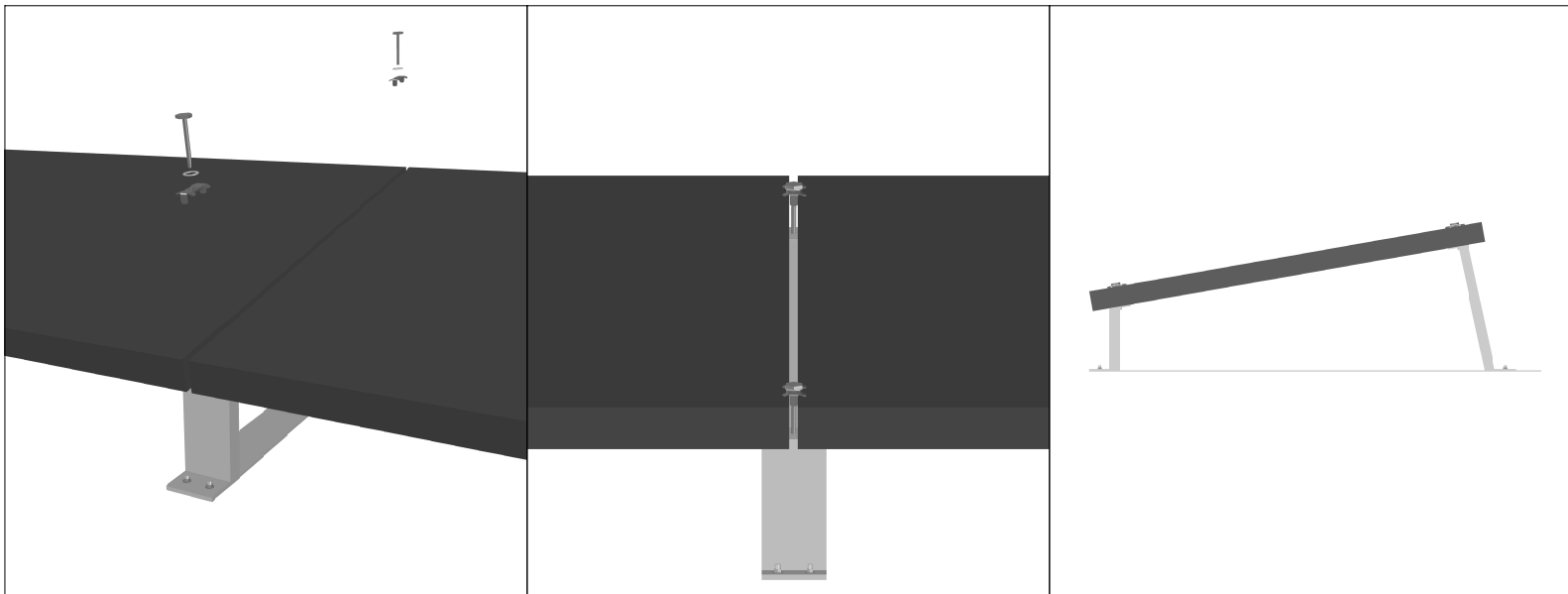

End Clamp with Integrated Ground Installation

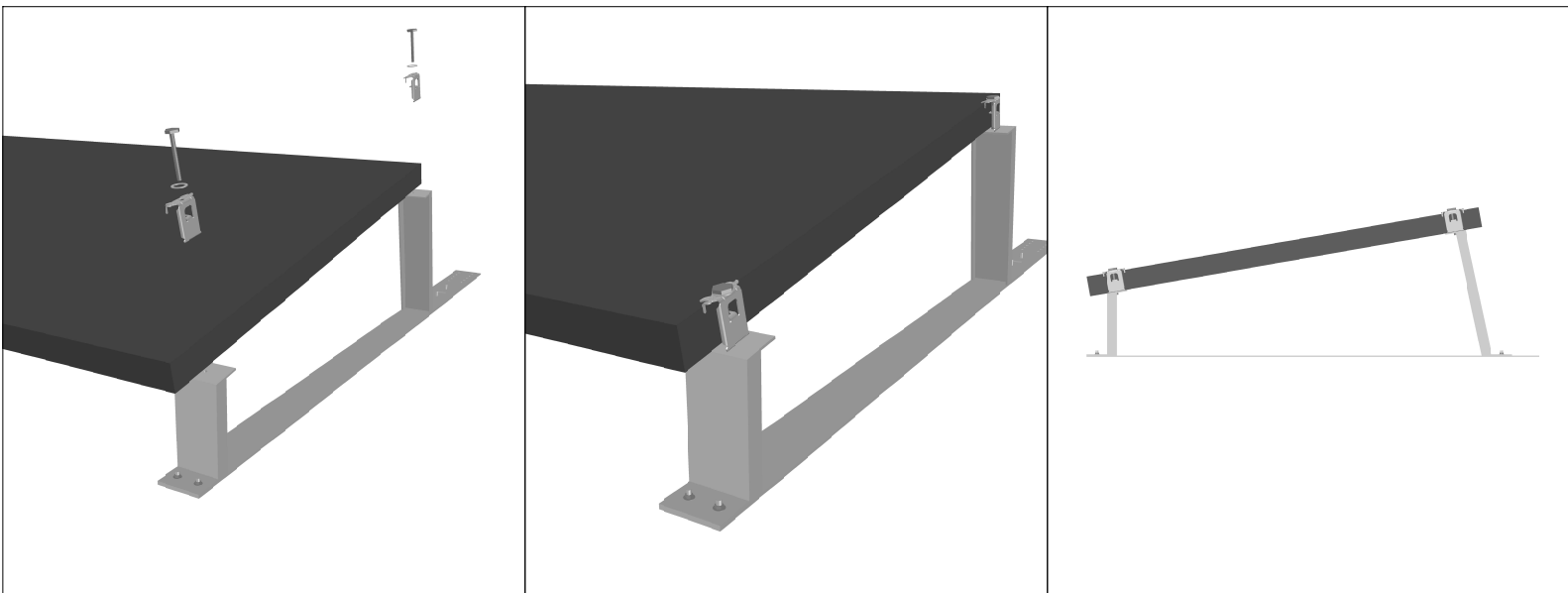

Note: For frameless modules, use Module Manufactures installation manual for torque spec or as specified in Appendix.

CAUTION

Over torquing could result in module damage and voiding of warranty. Never torque more than 55 in.-Lbs. Clamps must be in proper location with the bolt center at the least 2.5" from the frame edge.

INSTALLATION

Wire Management and Grounding

The SolarStap™ is certified by UL2703 to be used for integrated grounding in two directions. (1) primary from module to module bonded by the Conductive Mid Clamp A3003 and (2) Through the SolarStrap connected to Mid Clamp A3004 or End Clamp A3003. For frameless modules the SolarStrap Bond Bar (SSBB) is used to connect SolarStraps together to maintain a continuous bond. The Maximum number of adjacent bonded PV modules or Straps from the “Grounding Lug” (SGB-4 or SGB-5) attached to the first supporting bracket is limited by the inverter DC ground conductor size or 360 modules, no more than 40 modules across from the SolarStrap connected to the grounding lug. For installations where some of the modules cannot be installed adjacent to each other the following methods may apply.

- a. A solid #6 AWG copper conductor or A #6 AWG stranded wire with a maximum length of 30 feet bonded using approved grounding lug (SGB-4 or SGB-5)
- b. Use of SSBB to bond gaps; including walkways

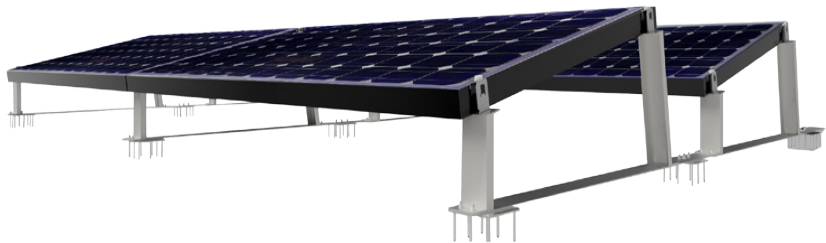

CAUTION

Keep copper away from aluminium and galvanized steel.

Simply attach ground wire to the provided Grounding Lug (SGB-4 or SGB-5) fastened to the wing of the low or high bracket and connect the ground wire to the pull box that is mounted on the back of the high bracket. From the pull box run ground wire all the way to the inverter or combiner box per the electrical engineering drawing.

PVC Schedule 80, EMT, IMT, or Rigid conduit may be secured to any part of the brackets and should be six inches or more above the roof to minimize heat gain and wire heat losses. Conduit may pass under the array to take the most direct path to inverters or combiner boxes. For wire management use EMT or Schedule 80 PVC conduit supported by a one-hole strap and one self tapping screw to attach your conduit to the side of the wing. Use plastic end protection if using EMT. EMT should be avoided for inter row crossings if the local AHJ requires bonding of EMT at these locations.

Note: A SSBB is only required on frameless modules, to bond the rows to columns. One per bonded 40 modules.

Grounding the Array Example

Up to 360 modules in an array requires a grounding lug (SGB-4 or SGB-5/Torque to 55 in. Lbs) secured to one bracket. A #6 AWG copper or stranded wire equipment ground bonds each grounding lug (SGB-4 or SGB-5/Torques to 55 in. Lbs) to the Earth Ground. The array may be up to 200 feet in each. The grounding lug must be placed on a continuous strap. Stranded rows of modules may ground through straps to the adjoining row. For islands of modules a #6 AWG copper or stranded wire jumper ground wire connects islands of modules together through grounding lugs (SGB-4 or SGB-5/Torque to 55 in.Lbs) secured to one bracket per section. A SolarStrap™ Bond Bar (SSBB) can also be used.

- A solid #6 AWG copper conductor or A #6 AWG stranded wire with a maximum length of 30 feet bonded using approved grounding lug (SGB-4 or SGB-5)
- Use of SSBB to bond Frameless module straps together since bonding is not available through a module frame
- Use of SSBB to bond gaps; including walkways

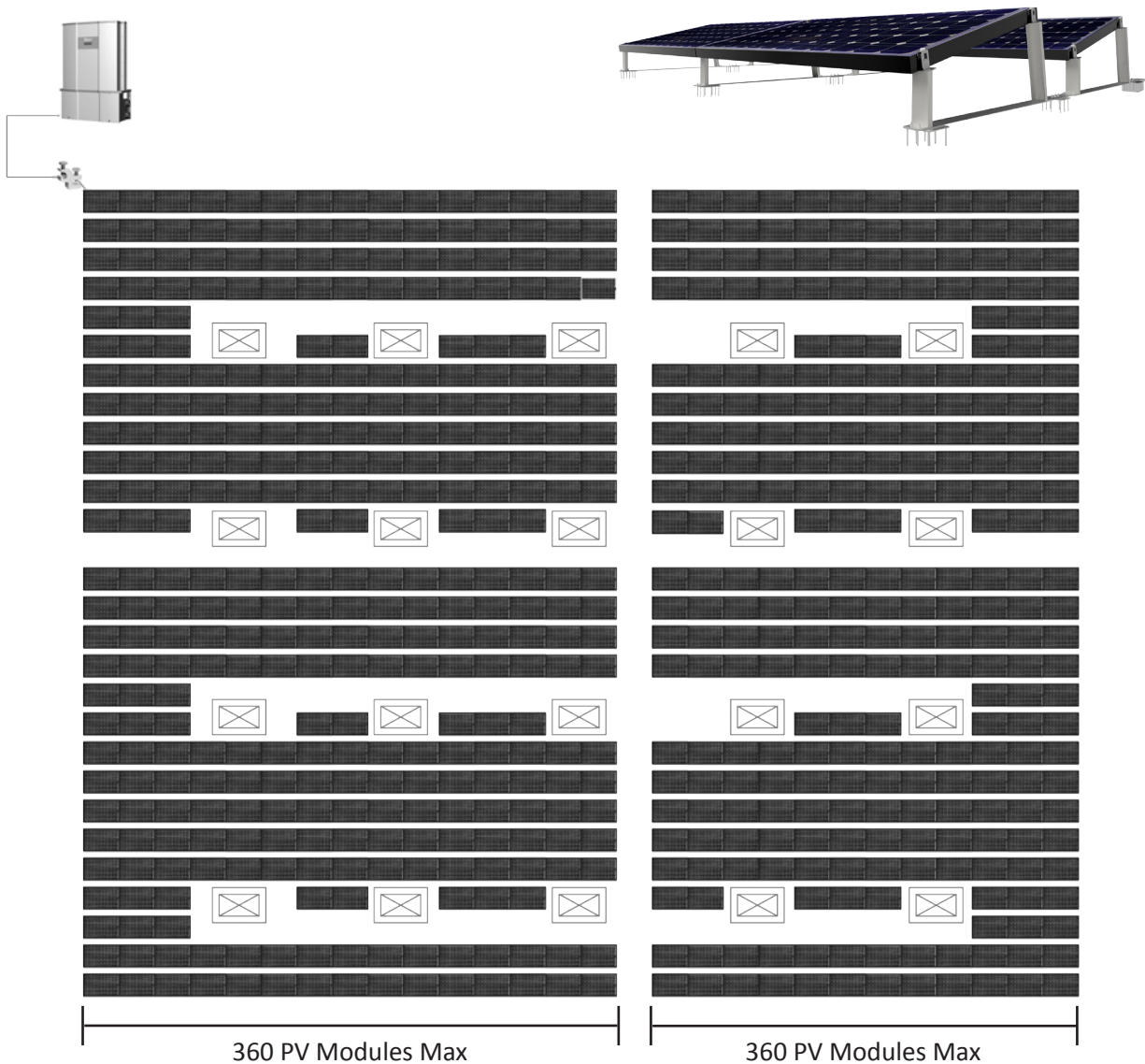

SEISMIC ENGINEERING

Application of Seismic Building Codes

PermaCity SolarStrap™ is uniquely suited for installation of rooftop mounted PV solar systems in seismically active areas and on buildings with limited roof structural capacity. Due to its light weight and flexible mounting options, the PermaCity SolarStrap™ is a viable option for a wide range of rooftops. Our design allows the PermaCity SolarStrap™ to be mounted to the roof using one of three mounting options: structurally attached; ballasted; and a hybrid option that uses both ballasted and structural attachments. Calculations have been performed in accordance with the 2013 California Building Code (CBC), the governing building code in California, which references the 2012 International Building Code (IBC). The 2012 IBC references the 2010 Minimum Design Loads for Buildings and Other Structures, including Supplement No. 1, No. 2, and Errata, by the American Society of Civil Engineers (ASCE), referred to as ASCE 7-10. The anchorage designs have been designed to withstand code-prescribed seismic forces due to the self-weight of the racking system, the self-weight of the solar panels and the system's ballast, if present.

Our structural analysis and design of the PermaCity SolarStrap™ and its method of attachment (ballasted, structurally attached and the hybrid ballasted with structural attachment) complies with Section 13.4 of ASCE 7-10, which states that all components shall be positively fastened to the structure without consideration of frictional resistance. The intent of our design is to provide a solution for various design parameters for seismic anchorage in a variety of site-specific conditions. Since there are many different possible seismic conditions, we can provide a site-specific seismic anchorage configuration with calculations to assure a safe installation and to obtain building permits. The seismic forces used in our calculations assume Site Class D and utilize short- period spectral accelerations as provided in ASCE 7-10. The design parameters may also be customized by roof material type.

Limita

For certain projects, site specific engineering may be recommended to help determine a very efficient custom installation cost. These various building-specific issues must be evaluated by the appropriate registered professional(s) prior to the addition of the photovoltaic and racking systems. A licensed structural engineer shall be consulted for building-specific structural evaluation.

Attachment Details



TPO OR PVC ROOF

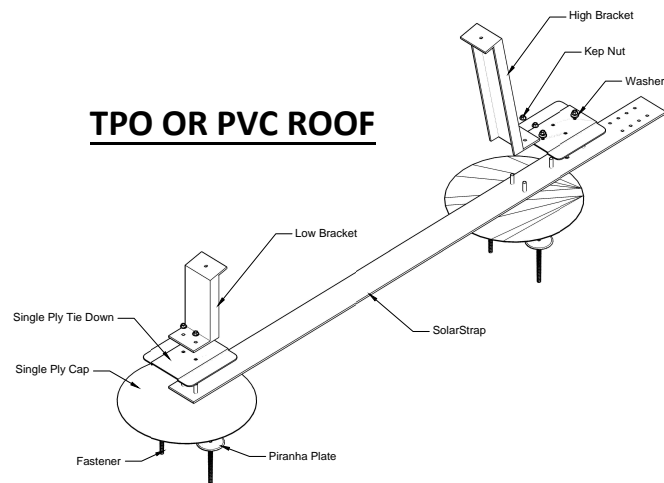

NOTES

Parts List

Product	Product Number	Number	Note
SolarStrap™ One Piece	SSOP3		
SolarStrap™ Bond Bar	SSBB		
SolarStrap™ SolarStrap	SSSS4		
SolarStrap™ Universal Connect Strap	SSUCS4		
SolarStrap™ Pan Strap	SSPS4		
SolarStrap™ Inverter Mount Rack	SSIMR		
SolarStrap™ Attachment Plate	SSAP		
SolarStrap™ Attachment Plate Heavy Duty	SSAPHD		
SolarStrap™ High Bracket 5°	SSHB5		
SolarStrap™ High Bracket 10°	SSHB10		
SolarStrap™ High Bracket 15°	SSHB15		
SolarStrap™ Double High Bracket 5°	SSHBEW5		
SolarStrap™ Double High Bracket 10°	SSHBEW10		
SolarStrap™ Double High Bracket 15°	SSHBEW15		
SolarStrap™ Low Bracket 5°	SSLB5		
SolarStrap™ Low Bracket 10°	SSLB10		
SolarStrap™ Low Bracket 15°	SSLB15		
SolarStrap™ Double Low Bracket 5°	SSLBEW5		
SolarStrap™ Double Low Bracket 10°	SSLBEW10		
SolarStrap™ Double Low Bracket 15°	SSLBEW15		
Conductive Mid Clamp	A3004		
Conductive End Clamp	A3003		
Grounding Lug	SGB-4		
Grounding Lug	SGB-5		
Serrated Hex Flange Nut	SSHWSFN		
Thin Film End Clamp with Star Washer	SSPS4		

CERTIFICATIONS AND APPROVED MODULES

TÜV UL2703 - Conformance

Fire Conformance

TÜV Rheinland Reference File: R1-PMC150609
L2-PMC150609

Mechanical Conformance







TÜV Rheinland Reference File: L1-PMC151112
L4-PMC150609

Electrical Conformance

TÜV Rheinland Reference File: L1-PMC161026
L1-PMC170505
L1-PMC170615
L3-PMC150609

TÜV UL2703 - Approved Modules

Testing Approval

Manufacture	Model	Electrical Bonding	Fire Type
 SunEdison simplifying solar	SunEdison 270W	X	2
 HYUNDAI HEAVY INDUSTRIES CO.,LTD.	MI-Series, HIx-xxxHI	X	1
SUNPOWER	SunPower 327W SunPower 395W	X X	2 2
 SUNPREME	Sunpreme GX-Series	X	3
 SOLARWORLD	SolarWorld 285W	X	1
 LG	LG 280W	X	1
 ecoSolargy inc.	ecoSolargy 300W	X	1

Design Load Rating

Manufacture	Model	Surface Area (SQFT)	Downward Design Load (PSF)	Upward Design Load (PSF)	Down-Slope Design Load (PSF)
 HYUNDAI HEAVY INDUSTRIES CO.,LTD.	MI-Series, HIx-xxxHI	20	30	5	5

WARRANTY

SolarStrap™ Limited Warranty Statement

Product	Product Number	Duration of Limited Warranty
SolarStrap™ One Piece	SSOP3	20 Years
SolarStrap™ SolarStrap	SSSS4	20 Years
SolarStrap™ Universal Connect Strap	SSUCS4	20 Years
SolarStrap™ Attachment Plate	SSAP	20 Years
SolarStrap™ Attachment Plate Heavy Duty	SSAPHD	20 Years
SolarStrap™ Pan Strap	SSPS4	20 Years
SolarStrap™ High Bracket (5°, 10°, 15°)	SSHB	20 Years
SolarStrap™ Double High Bracket (5°, 10°, 15°)	SSHBEW	20 Years
SolarStrap™ Low Bracket (5°, 10°, 15°)	SSLB	20 Years
SolarStrap™ Double Low Bracket (5°, 10°, 15°)	SSLBEW	20 Years
Conductive Mid Clamp	A3004	20 Years
Conductive End Clamp	A3003	20 Years

A. Extent of Limited Warranty

1. PermaCity warrants to the end-user customer that the PermaCity products specified above will be free from defects in materials and workmanship for the duration specified above, which duration begins on the date of purchase by the customer.
2. PermaCity's limited warranty covers only those defects that arise as a result of normal use of the product, and does not cover any other problems, including those that arise as a result of:
 - a. Improper maintenance or modification;
 - b. Parts or supplies not provided or supported by PermaCity;
 - c. Operation outside the design specifications or engineering;
 - d. Unauthorized modification or misuse.
3. If PermaCity receives, during the applicable warranty period, notice of a defect in any product which is covered by PermaCity's warranty, PermaCity shall either repair or replace the product, at PermaCity's option.
4. If PermaCity is unable to repair or replace, as applicable, a defective product which is covered by PermaCity's warranty, PermaCity shall, within a reasonable time after being notified of the defect, refund the purchase price for the product.
5. PermaCity shall have no obligation to repair, replace, or refund until the customer returns the defective product to PermaCity.
6. Any replacement product may be either new or like-new, provided that it has functionality at least equal to that of the product being replaced.
7. PermaCity products may contain remanufactured parts, components, or materials equivalent to new in performance.
8. PermaCity's Limited Warranty Statement is valid in any country where the covered PermaCity product is distributed by PermaCity. Contracts for additional warranty services, such as on-site service, may be available from any authorized PermaCity service company in countries where the product is distributed by PermaCity or by an authorized importer.

B. Limitations of Warranty

To the extent allowed by local law, neither PermaCity nor its third party suppliers makes any other warranty or condition of any kind, whether express or implied warranties or conditions of merchantability, satisfactory quality, and fitness for a particular purpose.

C. Limitations of Liability

1. To the extent allowed by local law, the remedies provided in this Warranty Statement are the customer's sole and exclusive remedies.
2. To the extent allowed by local law, except for the obligations specifically set forth in this warranty statement, in no event shall PermaCity or its third party suppliers be liable for direct, indirect, special, incidental, or consequential damages, whether based on contract, tort, or any other legal theory and whether advised of the possibility of such damages.

- D. Projects located within 2.5 miles of the ocean must use marine grade option, using either coated stainless steel serrated hex flange nut, pem studs, and pem nuts or these items made in aluminium.

The only warranties for PermaCity products and services are set forth in the express warranty statements accompanying such products and services. Nothing herein should be construed as constituting an additional warranty. PermaCity shall not be liable for technical or editorial errors or omissions contained herein. In order to keep full warranty, please design and build per installation manual guidelines.

PermaCity requires periodic re-inspection of the installation for loose components, loose fasteners and any corrosion, such that if found, the affected components are to be immediately replaced.

SolarStrap™ Installation Manual
Copyright© 2017 by PermaCity. All rights reserved.

www.solarstrap.com